



# Distributed Lighting Controls

Design Guide

# Table of Contents

Introduction to Echo and Echoflex .....	1
Office Space Model .....	2-3
Hospitality Model .....	4-5
Classroom Model .....	6-7
<b>Riser Diagrams</b>	
Open Office Space Riser .....	8
Conference Room Riser .....	8
Private Office Riser .....	9
Open Office with BMS Integration Riser .....	9
Classroom Riser .....	10
Ballroom Riser .....	10
Restaurant Riser .....	11
Hotel Room Riser .....	11
<b>Product Gallery</b>	
Fixture, Zone, and Room Controllers .....	12-13
Switches and Control Stations .....	14-15
Sensors and Responsive Controls .....	16-17
Interfaces and Gateways .....	18-19
HVAC Controls and IoT Sensors .....	20
Power Infrastructure .....	21



## Echo and Echoflex Lighting Control Systems from ETC

ETC's Echo and Echoflex distributed lighting control systems make intelligent, comprehensive control possible in any space. Echo's wired products offer stylish, powerful options in a system that's easy to install. And Echoflex wireless devices offer rock-solid connectivity with unbeatable flexibility. With them, designers can make systems that meet the most stringent of energy codes but are still simple to deploy, scalable, and virtually maintenance free.

Boasting a full suite of network connectivity options, Echo and Echoflex mesh well with each other to create hybrid solutions that are proven and reliable. They also communicate easily with building management systems, so even though control is distributed, it's easy to integrate them into comprehensive facility management systems.

Together, Echo and Echoflex products make the ultimate distributed lighting control solution.



## Always be energy conscious

With Echo and Echoflex, environmentally-friendly design meets sound business sense. Occupancy/vacancy sensors (PIR or dual tech) and light sensors (lumen level and color temperature sensing) help to conserve energy and reduce costs. Smart controllers with adjustable configuration parameters deliver control of individual fixtures as well as individual or multiple spaces, helping buildings meet demanding energy codes in the most cost-effective manner. Echoflex also supports communication with HVAC systems such as demand control ventilation applications.

### System Interface Choices

Industry-leading interfaces mean automation and customization at your fingertips. Stylishly designed control stations complement any decor with a variety of button configurations, colors, and customized labeling. The EchoAccess app allows users to remotely control their systems via Bluetooth or WiFi from any iOS or Android device. The EchoTouch touchscreen offers advanced preset programming and control in a sleek and attractive form factor.

### Control that expands with your business

Echo and Echoflex are ideal for lighting control retrofits or tenant improvements. New offices and areas can be added to the system without interrupting lighting in the rest of the building. Systems can also be reconfigured – and in the case of Echoflex wireless sensors and stations, even relocated – easily. New construction also benefits from this scalability, as core and shell can be completed with tenant improvement to follow.

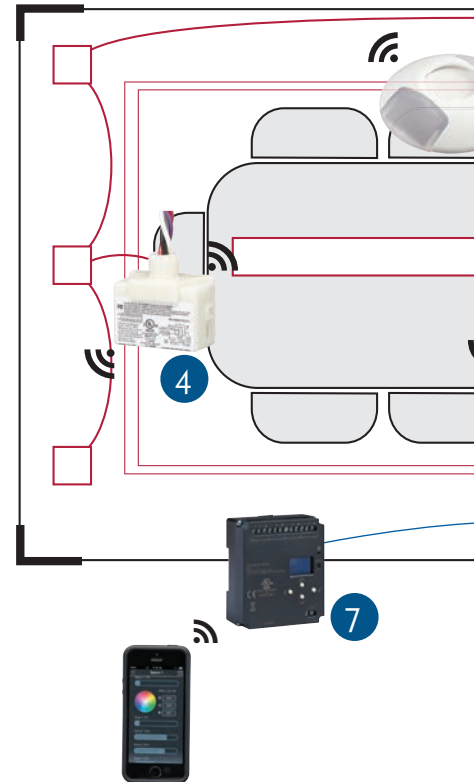

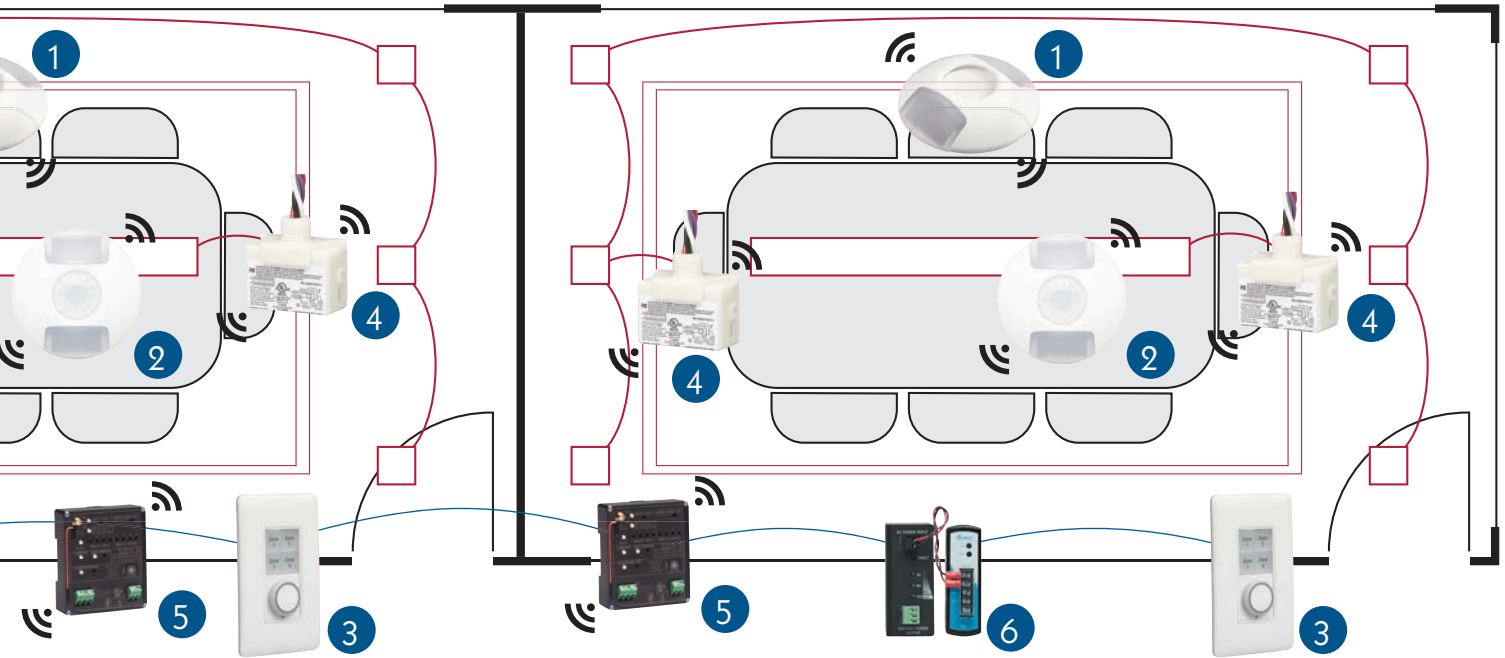

\* See conference room control riser on page 8

### 1 Light Sensors

Detect natural and electric light level contribution and reduce electric lighting to save energy. Includes CCT-sensing technology for human-centric lighting applications.

### 2 Dual Tech Occupancy/Vacancy Sensors

Whether the lights are turned on automatically with a sensor or manually with a switch, Echoflex sensors will turn the lights off when the space is empty.

### 3 Control Stations

Sleek button and fader stations, with wireless and battery-free models that can be located anywhere for convenient lighting control.

### 4 Zone Controllers

Can divide spaces into zones to control areas of light separately or all together.

### 5 Echo-Echoflex Interface

The Echo-Echoflex Interface allows for wireless communication between Echo and Echoflex control systems. When it's not practical to run wires between every device in your building's control system, the Echo-Echoflex Interface is the solution.

### 6 Easy Wiring

Echoflex's wireless connectivity makes placing sensors, stations, and zone controllers a breeze. And with Echo's configuration- and topology-free network even the wired option is easy.

### 7 Echo Expansion Bridge

Supports up to 64 Echo stations and sensors within a single Echo control system. When a wireless access point is connected to the system, the Echo Expansion Bridge provides remote control and configuration of any Echo system via iOS and Android smartphones and tablets, with varying levels of password protection and access.



## Giving guests more

It all starts with a guest and making their stay as pleasant and comfortable as possible. ETC ensures a luxurious visit with sensors and controllers that manage tunable white lights to help weary guests rest better; keycard switches to automatically turn amenities on; temperature sensors to keep the climate perfectly adjusted, and more. We don't forget the business side, either, with a full line of responsive controls to save on energy costs and easy integration into larger BMS and HVAC systems to keep costs low for the competitive hospitality market.

### Relaxing retrofits

A hotel may be a classic landmark, but energy codes are constantly changing and the hospitality industry has to keep up. Echo's forward-thinking design and Echoflex's wireless technology mean it's easy to retrofit any venue. Echo's topology-free network structure keeps things simple for contractors. Echoflex's wireless sensors, switches, and dimmers remove any obstacles existing construction may present.

### On point style

Guests expect more from hotels now and with ETC it's easy to deliver. Stylish switch stations and powerful programming tools mean custom presets and specialized looks for ballrooms and meeting spaces are just a tap away. The EchoAccess app gives staff the ability to control lights directly on their smartphone or tablet, creating the perfect setting for the guest experience.

- 1 Easy Switching**  
A variety of wireless switching options make it easy to automate room power state options whenever a guest enters or leaves.
- 2 Environmental Controls**  
Temperature setback controllers keep a room perfectly comfortable for guests and maximize energy efficiency.
- 3 Zone Controllers**  
Can divide spaces into zones to control areas of light separately or all together.
- 4 Receptacle Circuit Control**  
Linked or individually controlled receptacles make it easy to meet energy codes.
- 5 Occupancy/Vacancy Sensors**  
Automatically turn lights on when a room is in use, and switches them off when a room becomes vacant.

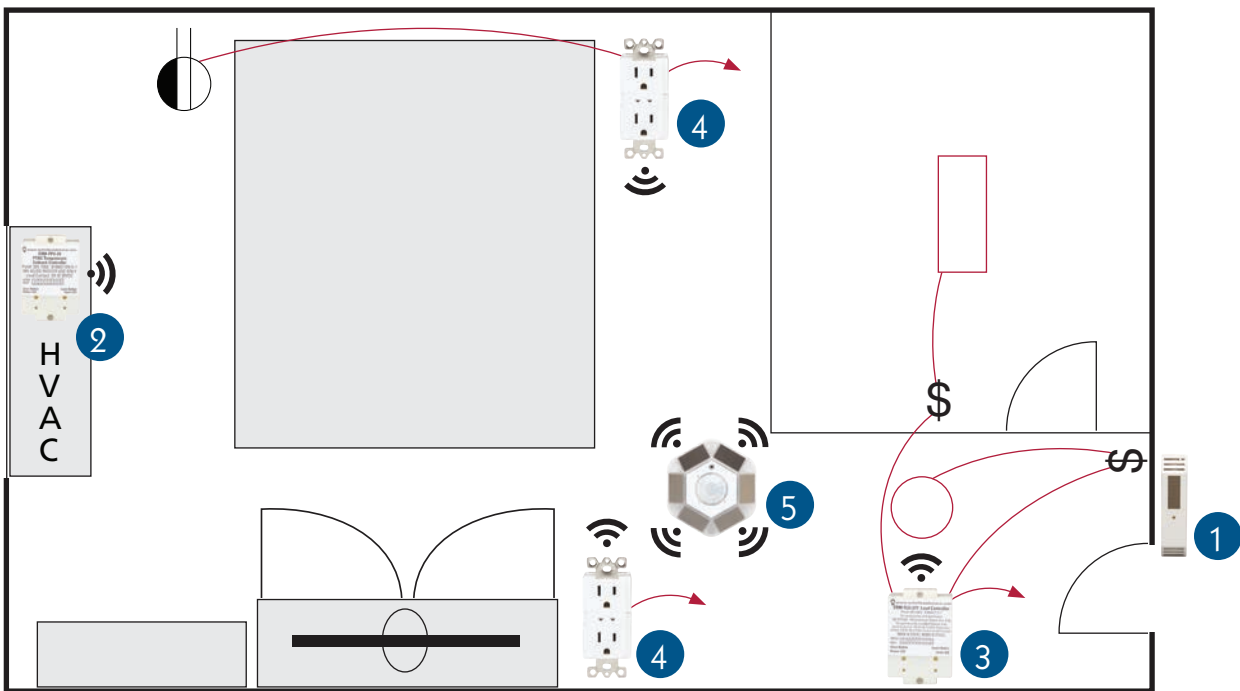
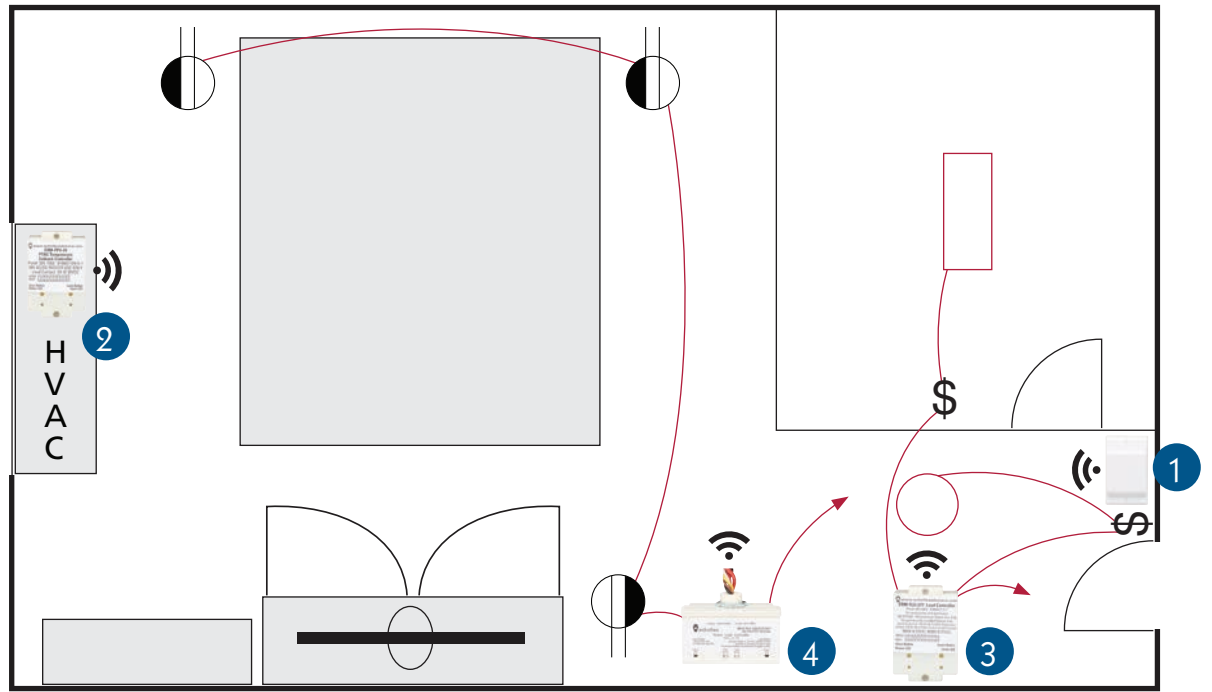



## Customized lesson plans for overachievers

Every project, like every student, has different needs ... and resources. Our variety of wireless and wired controls means you'll have the right answer for every installation. A wide variety of stations and interfaces means ETC is friendly to every type of user and school budget.

### Advanced Placement

Echoflex's wireless technology means control stations, sensors, relays, dimmers, switches, and all your other lighting control needs can quickly be installed wherever you need them. And when wired is the way to go, Echo's topology-free wiring simplifies installation.

### Plays well with others

Contact interfaces and BACnet gateways mean your lighting system seamlessly integrates with your AV or building management system. Contact input interfaces accept triggers from external sources to change the lighting while contact output interfaces provide simple integration with third-party management solutions.

### Easy energy calculus

ETC turns schools green with its suite of advanced sensors. Echo light sensors monitor natural sunlight and adjust the output of the electric lighting accordingly, reducing power usage. Wireless Echoflex light sensors make retrofits easy, allowing you to place sensors wherever you need them, without the hassle of running new wire. A full range of occupancy and vacancy sensors, using PIR and dual tech sensing, offers more options for meeting energy code requirements.

### Individual Attention

Whether you need scheduling, multiple zones for daylighting, or multiple custom presets for a room, ETC has you covered. TimeClocks are easy to integrate into a system, and can be included in Room Controllers to create a mini-panel solution. Echoflex tri-zone controllers support up to three different zones for daylight harvesting. Stylish Inspire control stations make it easy to store and recall custom preset looks.

- 1 Zone Controllers**  
Can divide spaces into zones to control areas of light separately or all together.
- 2 Light Sensors**  
Detect natural and electric light level contribution and reduce electric lighting to save energy. Optional sensors for tunable white applications.
- 3 Occupancy/Vacancy Sensors**  
Whether the lights are turned on automatically with a sensor or manually with a switch, Echoflex sensors will turn the lights off when the space is empty.
- 4 Control Stations**  
Sleek button and fader stations, with wireless and battery-free models that can be located anywhere for convenient lighting control.
- 5 Easy Wiring**  
A configuration-free and topology-free network that includes data and power on a single pair of wires to deliver distributed lighting intelligence. Easy wireless integration simplifies installation even more.



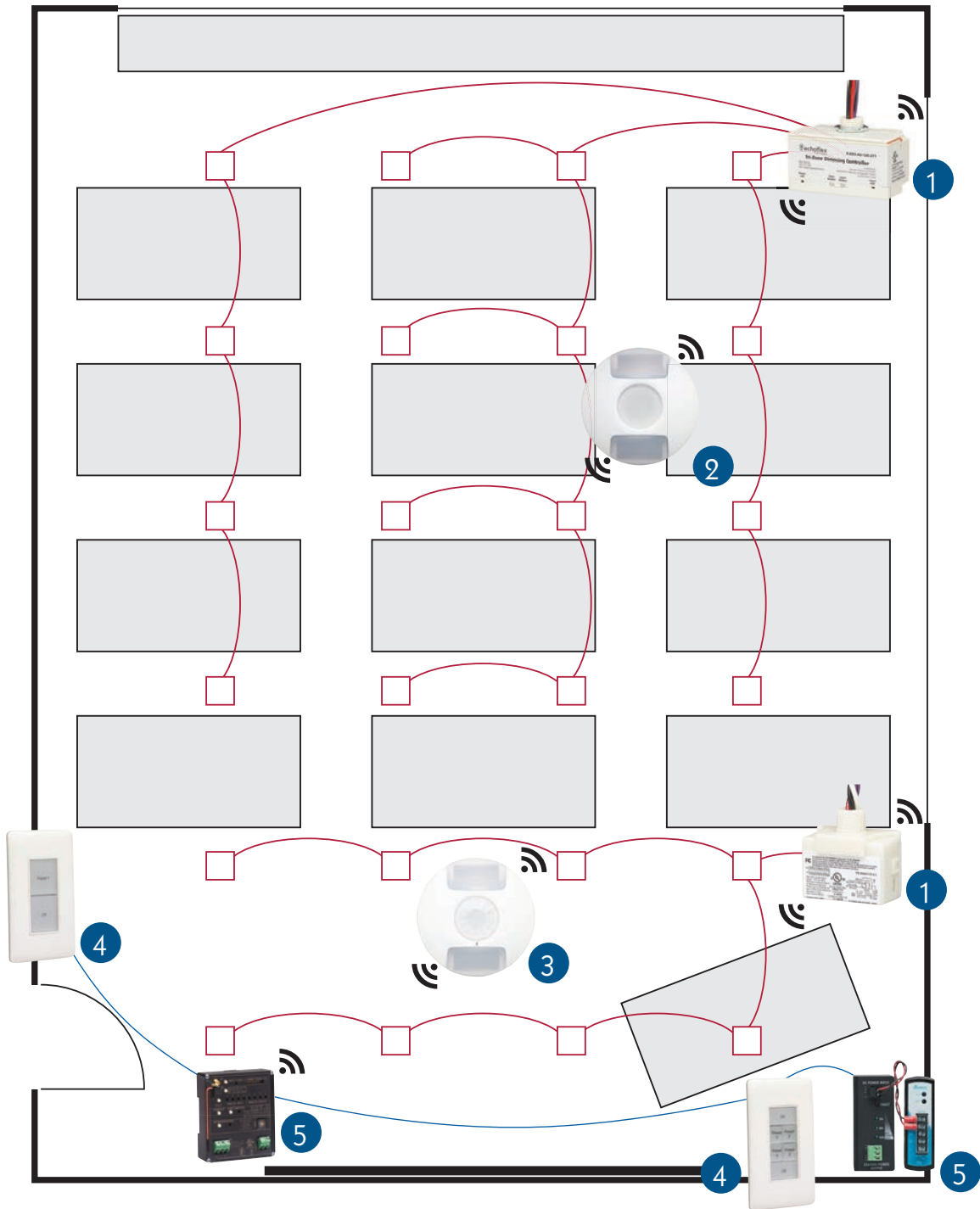
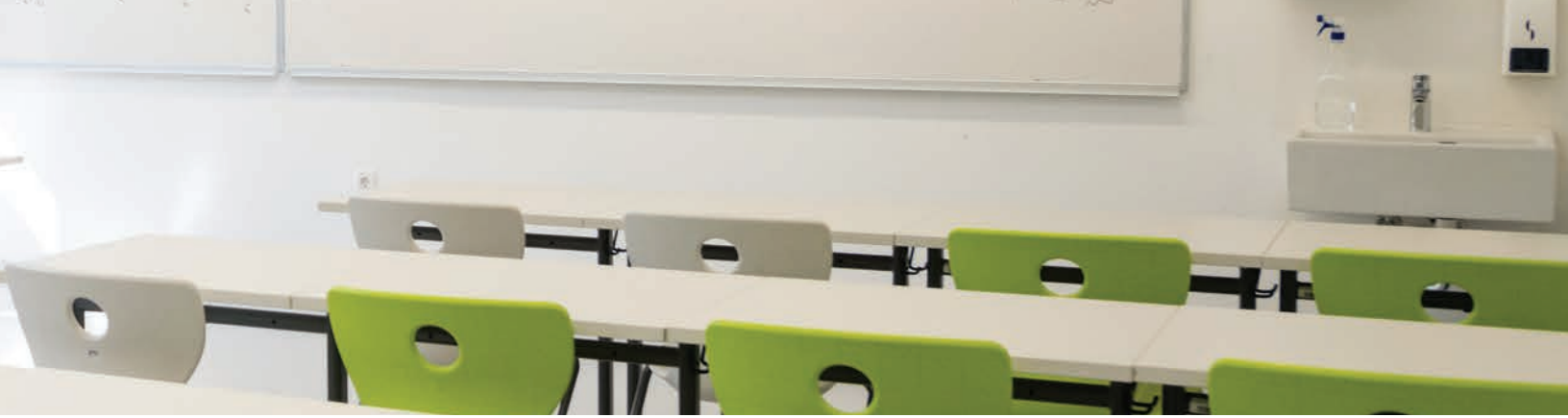

\* See classroom control riser on page 10

# Open Office Space

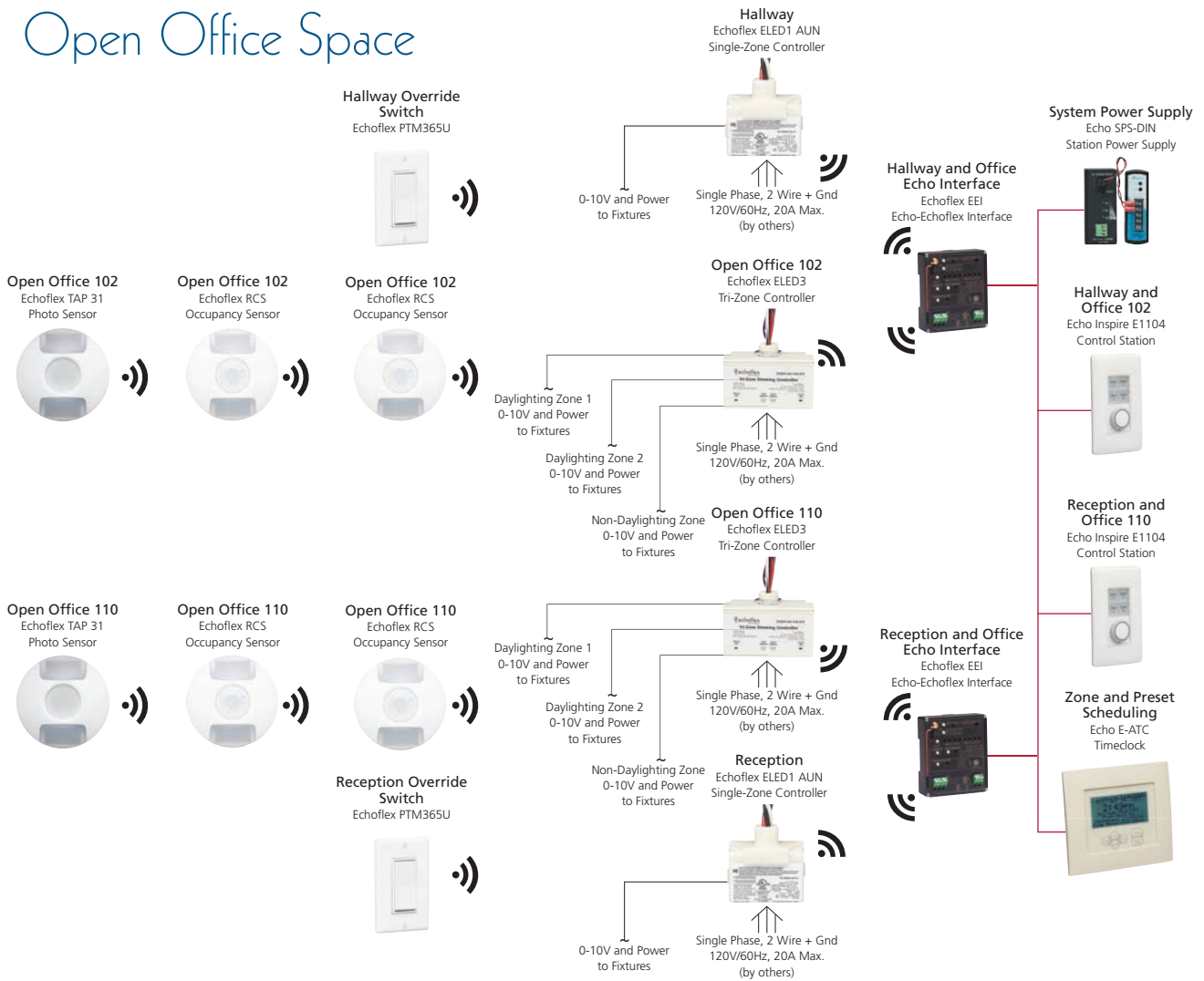

# Conference Room



# Private Office Space

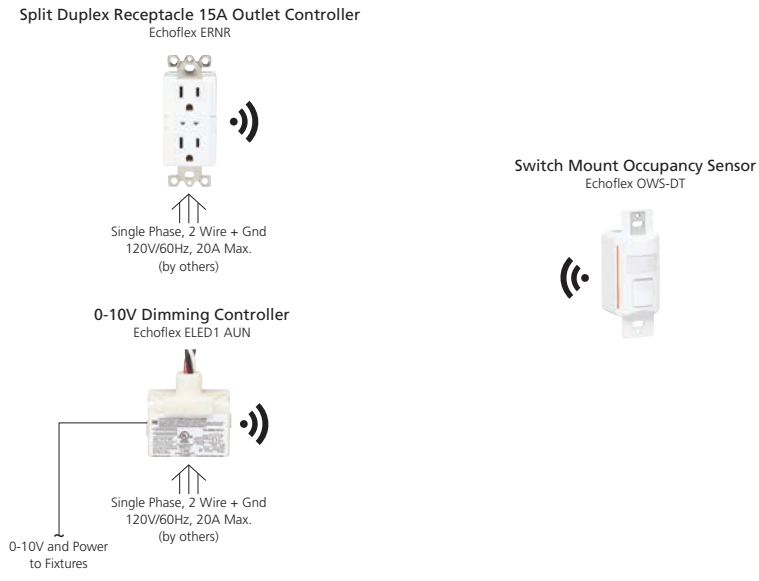

# Open Office with BMS Integration

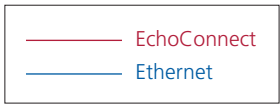
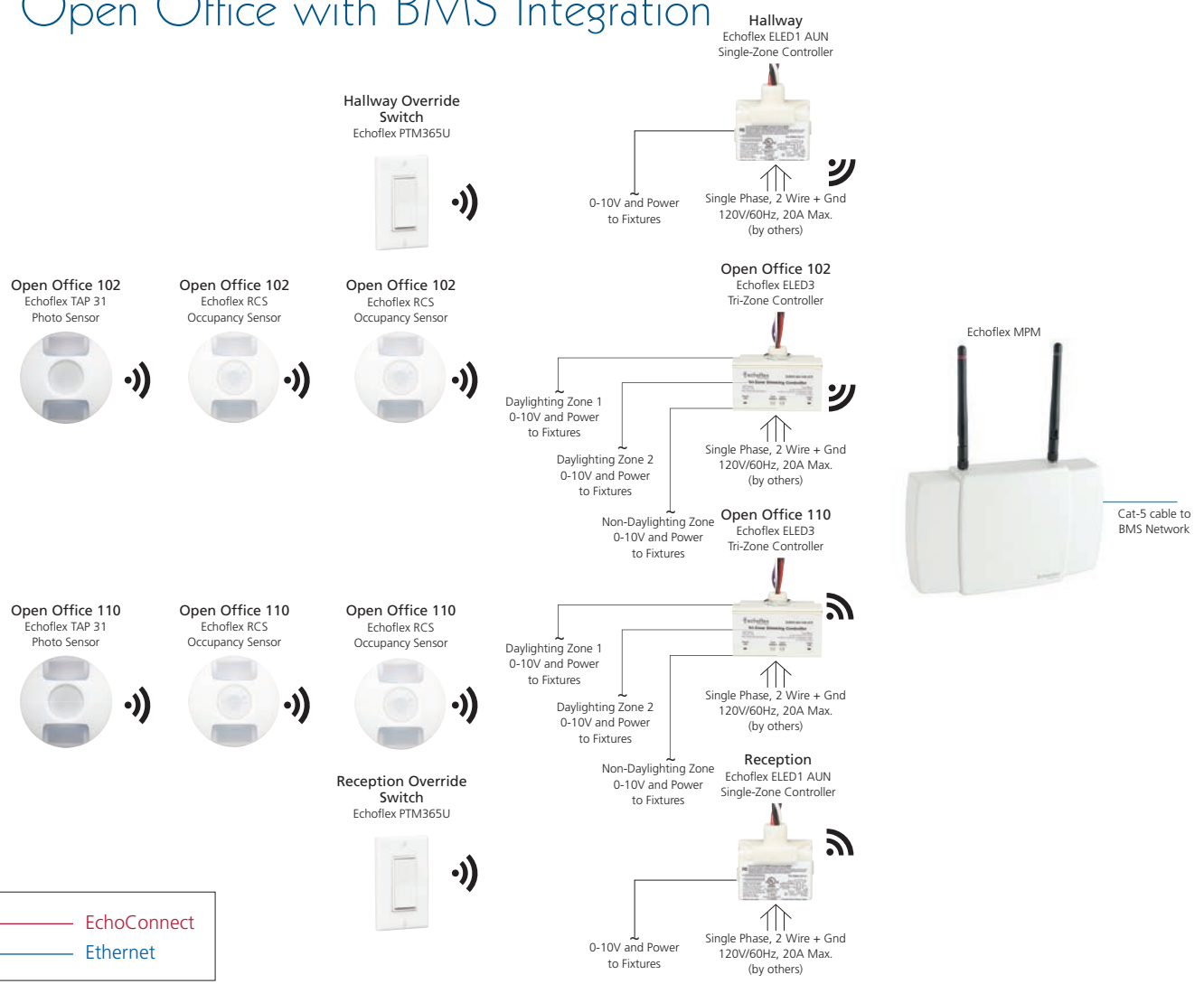

# Classroom

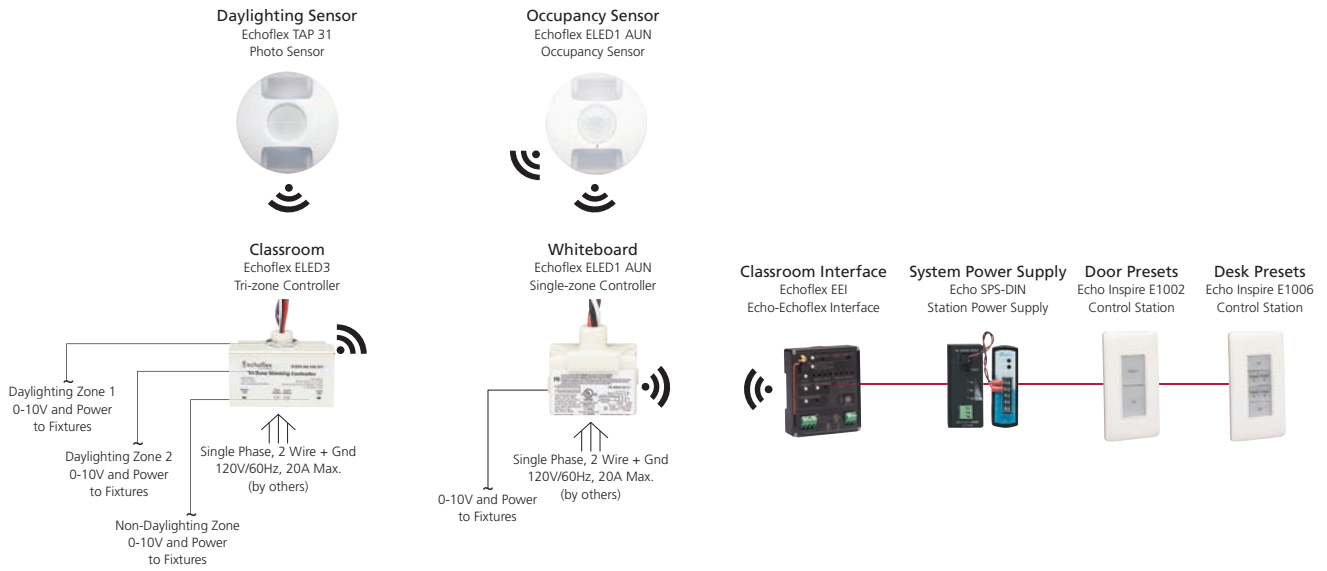

# Ballroom

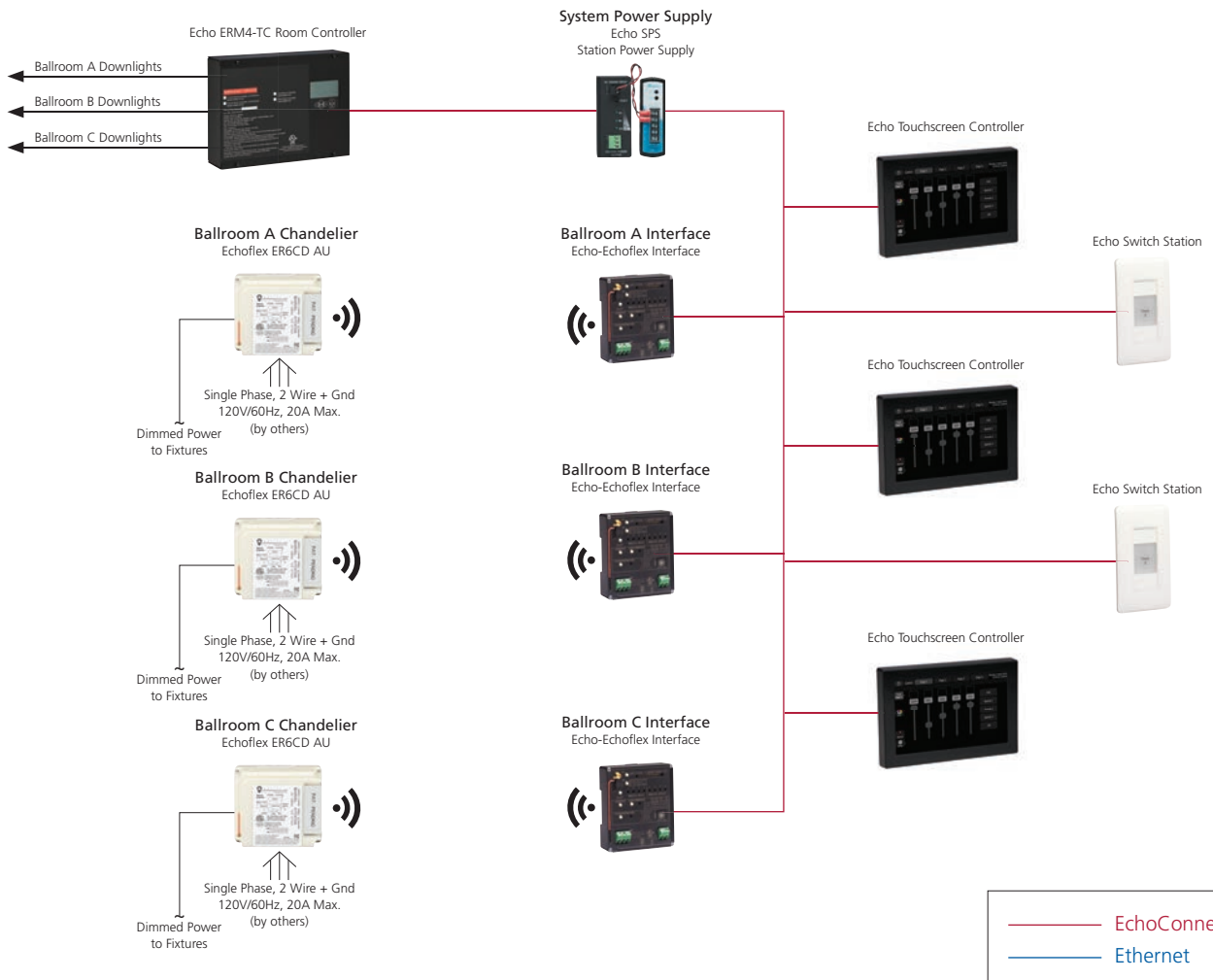

# Restaurant

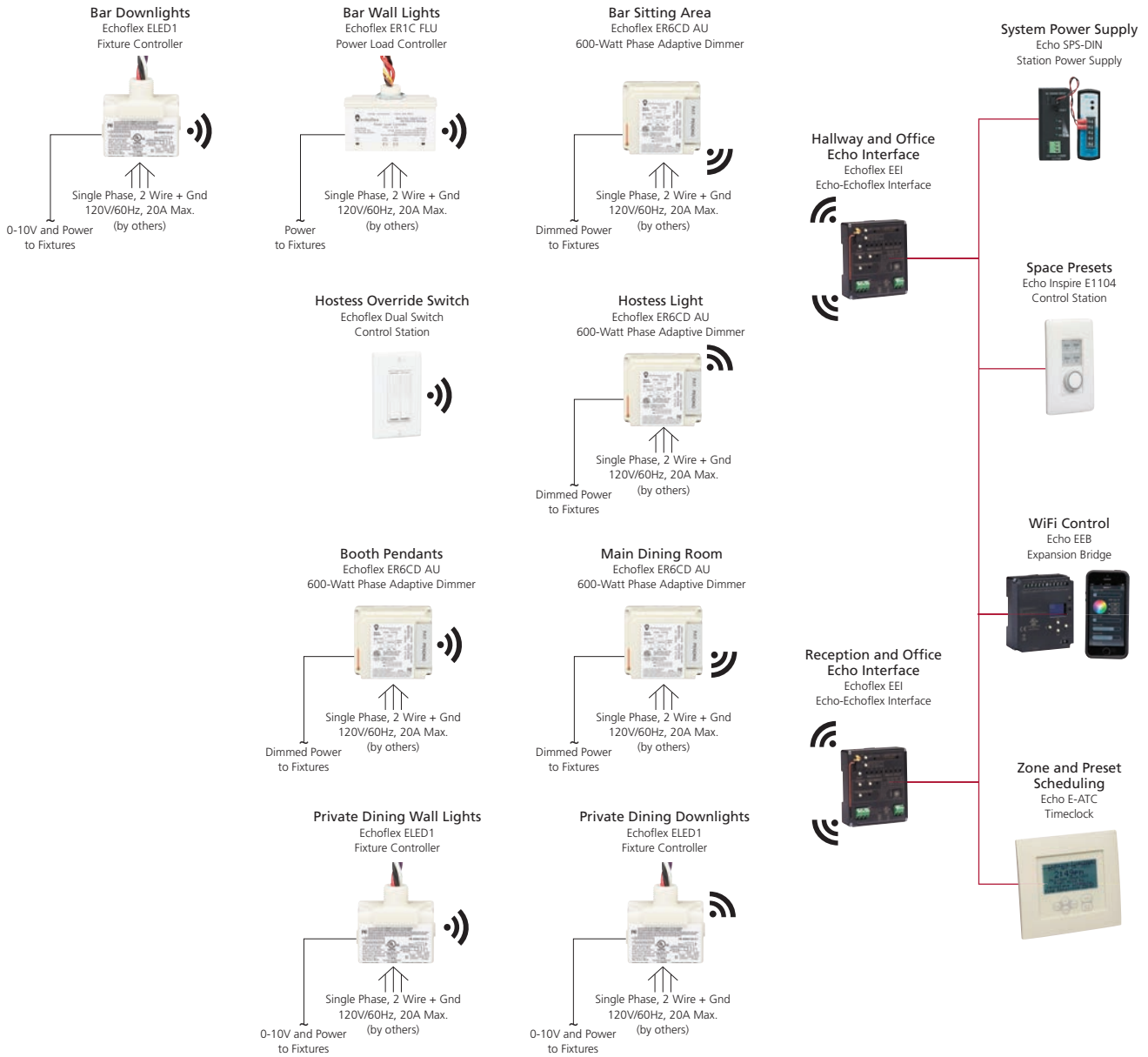

# Hotel Room

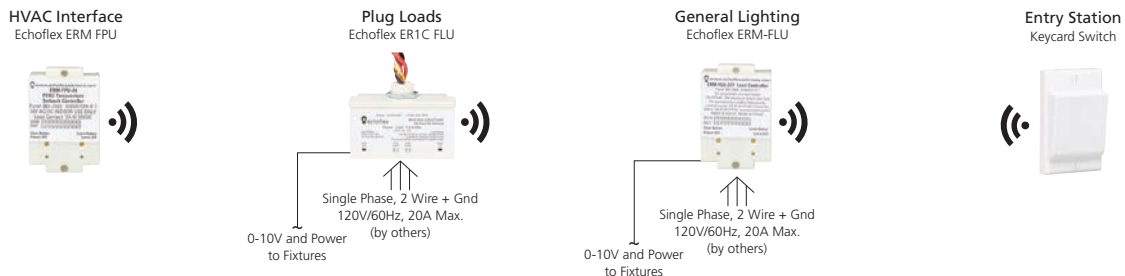



## Fixture, Zone, and Room Controllers



### Echoflex Single-Zone Fixture Controller

Model number ELED1

- Individual fixture/single-zone control
- Relay switching with 0-10V dimming
- Supports occupancy/vacancy sensing, partial on/off, and daylighting
- 120-277V at 11.5A
- UL 924 Listed



### Echoflex Tunable-White Fixture Controller

Model number ELED2

- Adjusts color temperature of tunable white fixtures
- Relay switching with 0-10V dimming
- Supports occupancy/vacancy sensing, partial on/off, and daylighting
- 120-277V at 20A
- UL 924 Listed



### Echoflex Tri-Zone Fixture Controller

Model number ELED3

- Control for three separate zones, for a complete daylight harvesting solution
- Relay switching with 0-10V dimming
- Supports occupancy/vacancy sensing, partial on/off, and daylighting
- 120-277V at 20A
- UL 924 Listed



### Echoflex 600-Watt Phase-Adaptive Dimmer

Model number ER6CD

- Reverse- or forward-phase single-channel 600-watt dimmer
- Individual fixture/single-zone control
- 120V or 277V input power models available (reverse-phase only at 277V)
- Integrated daylight harvesting control with Photo Inhibit feature



### Echoflex Power Load Controller

Model number ER1C

- Individual fixture/single-zone relay control
- Wall-switch, timed, photo/daylight, or occupancy-based control
- 20A relay for receptacle control
- 120/277V at 20A; 347V at 15A



### Echoflex Complete Room Dimming Controller

Model numbers ERDRC-FCU, ERDRC-FDU

- Individual fixture/single-zone control
- Relay switching with 0-10V dimming
- Responds to wireless wall switches, photo sensors, and occupancy sensors
- Responds to gateway control for scheduled events
- FC model supports wired occupancy sensor
- 120/277V at 20A; 347V at 15A



### Echoflex Control Module

Model number ERM-FL, ERM-FS

- Single-channel relay control of up to 20 devices
- 120-277VAC at 15A; 24VAC/DC with 3A @ 30VDC
- Wall-switch, timed, photo/daylight, or occupancy-based control
- Central-command capabilities for integration into BMS systems



### Echoflex Split Duplex Controller

Model number ERNR

- One 15-amp relay-switched outlet, one 15-amp constant-power outlet
- Wall-switch, keycard-switch, timed, door-switch, or occupancy-based control
- Gateway control implementing schedules or other events
- ETL and cETL Listed



## Echo Room Controller

Model number ERM C

- Four- and eight-zone models available
- UL 924 Listed with integrated Sense Feed
- Supports multiple control spaces in a single controller
- Independent 120V, 277V, emergency and plug-load control in a single controller
- 0-10V control and relay outputs
- Integral power supply for up to six stations and power/output controllers
- Optional integral TimeClock for timed events



## Echo Relay Controller

Model numbers ERC and EDRC

- One or two independently controlled outputs
- 120-277V power input
- Half-inch knockout mount
- Fully-rated 20A relay per output



## Echo 0-10V Controller

Model numbers ELD and EDLD

- One or two independently controlled outputs
- 0-10V output per relay for driver and ballast control
- 120-277V power input
- Half-inch knockout mount
- Fully-rated 20A relay per output



## Automatic Load Control Relay

Model number ALCR

- Automatic control of emergency power output to fixture or single zone emergency lighting upon loss of normal power
- UL 924 Listed
- Accepts Normal Sense Circuit and Class 2 Panic Circuit
- 120VAC and 277VAC
- Normally-closed, 20A fully-rated relay
- Power pack or DIN-rail form factors
- DIN-rail version supports 0-10V cutoff



## Echo Smart Space Controller

Model numbers ESSC and EDSSC

- One or two independently controlled outputs
- 0-10V output per relay for driver and ballast control
- 120-277V power input
- 24VDC output sensor power output
- Contact input for occupancy or photo sensor
- Half-inch knockout mount
- Fully-rated 20A relay per output



## Branch Circuit Emergency Lighting Transfer Switch

Model number SC1008

- UL1008 Listed to transfer a single 20A circuit at 120V or 277V
- Field-configurable fire alarm input can be normally open (N/O) or normally closed (N/C)
- Low-voltage relay breaks a 0-10V or DALI loop sending the drivers to full in an emergency state
- Standard push button and laser test options
- Automatically transfers load from normal power to emergency power
- Automatically transfers back to normal power when restored



## Echo Phase-Adaptive Dimmer

Model number ELVD

- Reverse- or forward-phase operation
- Dimming mode auto-detection with optional manual selection
- 120V and 277V versions (reverse phase only at 277V)
- Supports loads up to 600W
- One-watt minimum load
- Half-inch knockout mount



## Switches and Control Stations



### Echoflex Multi-Button Station

Model number MBI

- Multiple zone control and functions from one station
- Custom labelling options
- On/Off and dimming control



### Echoflex Wall Switch Sensor

Model number OWS-IR, OWS-DT

- Available with PIR or dual tech detection
- On/Off and dimming control
- Occupancy control of lighting and plug loads
- Wired and wireless, battery-powered versions available



### Echoflex Decorator Style Switch

Model number PTM265, PTM365

- Battery-free
- On/Off and dimming control
- Single- or dual-paddle
- PTM365 comes with UL and CSA certified barrier plate
- Available in Black, Almond, Ivory, White, or Gray finish



### Echoflex Hotel Keycard Switch

Model number PTM265KCA

- Keycard-activated switch for hospitality suite control applications
- No limitations on relay assignments



### Echoflex Wave Switch

Model number ETRS

- Battery-free
- On/Off and dimming control
- Single- or dual-paddle



### Echoflex Window/Door Contact Switch

Model number MC-21

- Solar-powered magnetic contact switch
- User-adjustable heartbeat



### Echoflex Handheld Switch

Model number ETRH

- Portable rocker-style switch
- Battery-free
- On/Off and dimming control
- Single- or dual-paddle



### Echoflex Active Circuit Transmitter

Model number ERM-DA

- Indicates when electrical 120-277V or 24VAC/DC circuit is active, allowing active circuit to trigger events
- Wireless repeater (single and dual hop) for boosting wireless signal for whole system





### Echo Inspire Button Stations

Model numbers E1001, E1002, E1004, E1006, E1008

- One, two, four, six, or eight buttons
- Easy-to-change, user-specific, back-lit button legends with preset or zone control
- Space raise/lower control
- Zone or preset activation with raise/lower control
- Fastener-free faceplate attachment
- Cream, Gray, Black, or White finish
- Optional space on/off button
- Optional room-combine control

### Echo Inspire Four-Button Fader Station

Model number E1104

- Fader station with four selection buttons for preset and zone control
- Real-time hue, saturation, and intensity control of LEDs when used with the DMX Scene Controller
- Easy-to-change, user-specific back-lit button legends
- Space raise/lower control
- Zone or preset activation with raise/lower control
- Fastener-free faceplate attachment
- Cream, Gray, Black, or White Finish



### Echo Touch

Model number ETS

- Touchscreen control interface
- Color control, color tuning, zone, preset, and sequence control
- Supports EchoConnect, DMX/RDM, sACN, and Art-Net protocols
- Discovery, addressing, and mode selection of RDM fixtures
- Available with Cream, Gray, Black, or White Bezel
- Locking cover available



### Echo TimeClock

Model number E-ATC

- Intuitive six-button interface
- Large backlit display
- Time-of-day and astronomical events
- Support for up to 16 spaces



### Echo Keyswitch

Model number EPSKS

- Keyswitch control of presets, zones, station lockout, or more
- Lockout by default, additional programming via app



### Echo Preset Stations

Model number EPS05 and EPS10

- Available in five- and ten-button options
- LED indicator per button
- Available in Cream, Gray, Black, or White finish



## Sensors and Responsive Controls



### Echoflex Vacancy/Occupancy Sensor

- Model number RVS, RCS, RVS-DT, RCS-DT
- Wireless self-powered and battery-powered occupancy/vacancy sensors
  - Passive infrared and dual technology (PIR and acoustic) models available
  - Walk test mode to ensure motion range coverage



### Echoflex Wall Switch Sensor

- Model number OWS-IR, OWS-DT
- Wired and wireless, battery-powered versions available
  - Passive infrared and dual technology (PIR and acoustic) models available
  - On/Off and dimming control
  - Occupancy control of lighting and plug loads

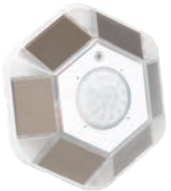

### Echoflex 360 Ceiling/High Bay Sensor

- Model number MOS-IR, MOS-DT
- Wireless, self-powered, occupancy/vacancy sensor
  - Passive infrared and dual technology (PIR and acoustic) models available
  - Ceiling-mount, 360-degree angle of detection
  - Special lensing option for high-bay applications (approx. 40 feet)
  - Immediate response on occupancy states, ideal for auto-on or partial-on applications
  - Options for small motion and large motion



### Echoflex TAP-31 Photo Sensor

- Model number TAP-31
- Wireless, self-powered photo sensor for daylight switching or dimming
  - Two selectable ranges: 0-1024 lux (95 fc) and 0-65535 lux (6090 fc)
  - Supports open- or closed-loop daylighting applications
  - Multiple mounting options
  - Self-adjusting transmission rates to reduce energy usage



### Echoflex TAP-41 Photo Sensor

- Model number TAP-41
- Wireless, self-powered photo sensor for daylight switching or dimming
  - Correlated color temperature feedback across a broad temperature range (1,000-10,000 K)
  - Multiple mounting options
  - Self-adjusting transmission rates to reduce energy usage



### Echoflex Occupancy Sensor

- Model number ROS-WA, ROS-HW, ROS-KM
- Wireless, self-powered occupancy sensor
  - Passive Infrared (PIR) detection
  - Wide-angle, hallway, and corner-mount models
  - Small-motion detection
  - Adjustable sensitivity to prevent nuisance triggering



### Echoflex Open Loop Photo Sensor

- Model number WDS9
- Wireless, solar-powered open-loop photo sensor
  - Indoor use only
  - Monitors light levels up to 65,000 lux/6000 foot-candles



### Echo Ceiling- and Wall-mount Dual Tech Occupancy/Vacancy Sensor

Model number E-DOC and E-DVAC

- Passive infrared and acoustic detection
- Occupancy and vacancy detection options
- Ceiling-mount, small-room, large-room, and high-ceiling options available. Wall-mount wide and narrow coverage available
- Thirty-second grace timer
- Walk test function for PIR and audio coverage
- Supports small motion detection up to 45 feet
- Up to 2,000-square-foot coverage
- Available in Black or White



### Echo Ceiling-mount PIR Occupancy and Vacancy Sensor

Model number EOCC and EVAC

- Occupancy and Vacancy sensor options
- Small-room, large-room, and high-ceiling options available
- Passive Infrared (PIR) detection
- Thirty-second grace timer
- Walk test function
- Available in Black or White



### Echo Light Sensor

Model number ELS

The Echo Light Sensor automatically adjusts light levels to your target lux level and even supports two-sensor averaging, making it ideal for indoor, outdoor, and atrium use.

- Remote head-mounting option
- Built-in target lux configuration
- Two-sensor averaging for ideal light levels in a light-changing environment
- Single-head option for indoor, outdoor, and atrium settings (0-6500 lux, 0-610 fc)
- Remote head is IP65 rated for mounting outdoors
- Available in Black or White



### Echo Switch-mount Dual Tech Occupancy Sensor

Model number E-DOC-SM

- Passive infrared and acoustic detection
- One- and two-button options available
- Thirty-second grace timer
- Walk test function for PIR and audio coverage
- Supports small motion detection up to 45 feet
- Cream, Gray, Black, or White finish



## Interfaces and Gateways



### Echoflex Demand Response Interface

Model number ERDRI

- Dedicated contact closure interface for Demand Response commands from utility
- Low-voltage interface



### Echoflex 4-Channel Contact Output Interface

Model number ERCOI

- Four wireless inputs and four dry SPDT outputs
- Each output can be individually controlled and linked to multiple switches or sensors
- Low-voltage interface to fire alarm, security, lighting, or control panels



### Echoflex Bidirectional BACnet Gateway

Model number MPM-GW

- Bidirectional Echoflex to BACnet gateway. Integrates Echoflex systems into BACnet building automation systems
- Programmable gateway for HVAC and/or lighting control applications



### Echoflex 4-Channel Contact Input Interface

Model number ERCII

- Four wired inputs and four wireless outputs (switch or occupancy)
- Each channel operates separately
- Low-voltage interface from fire alarm, security, lighting, or control panels
- Accepts dry contacts



### Echoflex USB Serial Interface

Model number ERUSB-S

- Provides access to Echoflex transmissions for PC-based monitoring and management of Echoflex wireless systems

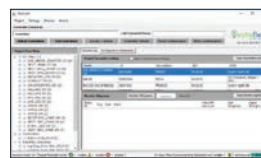

### Garibaldi Remote Commissioning Software

Garibaldi commissioning software allows in-field customization of Echoflex pre-commissioned control systems to ensure optimum performance.



## Echo Expansion Bridge

Model number EEB

- Combines up to four Echo segments for up to 64 control and output devices
- Connects to WiFi via network for use with EchoAccess mobile app or integration with Paradigm
- Utilizes EchoConnect control network plus 24VDC power



## Echo Echoflex Interface

Model number EEI

- Provides four inputs and four outputs for interface with Echoflex wireless devices
- Built-in 902 MHz EnOcean wireless radio
- Utilizes EchoConnect control network plus 24VDC power
- Allows EchoAccess to have mobile control of wireless Echoflex devices and touchscreen control of wireless devices via the EchoTouch



## Echo Contact Interfaces

Model numbers ECII and ECOI

- Available with four inputs or four outputs
- Inputs accept wet or dry contacts
- Inputs support momentary or maintained closures (per input)
- Output Interface provides triggers for third-party systems
- Outputs support normally open or normally closed operation (per output)
- Programmable through EchoAccess mobile app
- Utilizes EchoConnect control network plus 24VDC power



## EchoAccess

Model number EACC

- Enables configuration of connected Echo devices
- Activate, deactivate, and record presets
- Set light levels or combine spaces remotely
- Wall-mountable Bluetooth® interface with sleek design or WiFi connection using the Echo Expansion Bridge



## Echo DMX Scene Controller

Model number EDMXC

- Uses DMX-snapshot technology or EchoAccess to capture lighting presets
- Easy-to-use remote programming
- Controls hue, saturation, and intensity for multi-address DMX luminaires
- Supports up to 32 presets
- Dynamic Color Picker available with EchoAccess mobile app
- Utilizes EchoConnect control network plus 24VDC power



## Echo BACnet Interface

Model number EBI

- Allows Echo Control System integration with building management systems
- Supports BACnet IP for simple Ethernet based integration
- Utilizes EchoConnect control network plus 24VDC power



## Echo Demand Response Interface

Model number EDRI

- Accepts Demand Response contact closure to reduce total load during times of peak demand
- Shares Demand Response status across the Echo control network
- Utilizes EchoConnect control network plus 24VDC power





## HVAC Controls and IoT Sensors



### Echoflex Electronic Baseboard Controller

Model number ERM-FB

- Supports occupancy and Contact Switch set-back operation for energy savings
- Temperature averaging from multiple sensors
- Supports baseboard voltages of 120, 208, 240, and 277VAC
- Remote management and reporting for BMS integration



### Echoflex Temperature Setback Controller

Model number ERM-FP

- Interfaces with hospitality PTAC equipment for setback control
- Supports Keycard and Contact Switch
- Temperature- and occupancy-based control
- Central Command support for BMS gateway control



### Echoflex Temperature and Humidity Sensors

Model number RTS

- Wireless, solar-powered temperature and humidity sensor
- Additional models with temperature setpoint, fan speed, and occupancy override options
- Works with Echoflex Baseboard Controller and Echoflex Temperature Setback Controller to control heating equipment



### Echoflex CO2 Sensor

Model number RCT

- Wireless, solar-powered CO2, temperature, and humidity sensing
- Integrates well with any BMS
- Automated self-calibration feature
- Integrated pressure sensing for increased CO2 accuracy

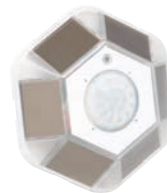

### Echoflex IoT Ceiling Sensor

Model number MOS-MT

- Wireless, solar-powered motion, sound, temperature, and light level sensor for IoT building monitoring and optimization applications



## Power Infrastructure

### Echo Relay Panel Mains Feed

Model number ERP

The Echo Relay Panel Mains Feed features relay and line dimming control, switching with integral breakers, and options for low-voltage control. Its built-in power supply supports up to six stations and power controllers.

- Supports 10A, 15A, or 20A breakers
- 30-circuit panel with support for 24 relays/dimmers and 5 hot circuits
- 20A mechanically-held air-gap relays
- Optional 300-watt dimmer available per circuit
- Optional 0-10V or broadcast DALI
- Astronomical and Real-time clock
- UL 924 Listed
- Optional contact input card



### Echo Relay Panel Feedthrough

Model number ERP-FT

The Echo Relay Panel Feedthrough offers creative power distribution for all load types with relay switching for multiple voltages in a single panel. Its built-in power supply supports up to six stations and power controllers.

- 120V and 277V power control
- Up to 48 relay outputs
- Optional 0-10V or broadcast DALI
- Astronomical and Real-time clock
- UL 924 Listed
- Optional contact input card
- Up to 48 mechanically-held air gap relays



### Echo Station Power Supplies

Model number E-SPS-DIN, E-SPS, and E-APS

The Station Power Supply provides power for stations, responsive controls, and power products. The Station Power Supplies come in a variety of mounting options and form factors, making them ideal for healthcare facilities, office buildings, retail locations, houses of worship, schools, and more.

- Supports up to 1640 feet of control wiring (Belden 8471)
- Supports up to 16 power products or power panels
- Supports up to 16 stations or responsive controls
- Multiple form factors and mounting options available
- Optional 24VDC auxiliary power output





**Corporate Headquarters** ■ Middleton, WI USA

**Global Offices** ■ London, UK ■ Rome, IT ■ Holzkirchen, DE ■ Paris, FR ■ Hong Kong ■ Singapore ■ New York, NY ■ Orlando, FL ■ Los Angeles, CA

Copyright©2019 ETC. All Rights Reserved. All product information and specifications subject to change. 7186L1029 Rev A 10/19

Trademark and patent info: [etcconnect.com/IP](http://etcconnect.com/IP)

[etcconnect.com](http://etcconnect.com)